

A cluster of blue lemons is centered on a light blue background. The lemons are rendered with a textured, slightly bumpy surface and are arranged in a dense, overlapping group. A white rectangular box with a black border is superimposed over the center of the lemons, containing the text for the module title.

Module 2: Protein engineering to create a model system for bioremediation of heavy metals

Overview of Module 2 goals

Research:

Genetically **modify** a yeast iron **transporter** to preferentially take up **cadmium** as a model for **bioremediation**

Communication:

Journal article presentation
Research article

Technical:









Protein engineering:

Site-Directed Mutagenesis
Mutant expression

Functional assays:

Elemental analysis of metal uptake
Cell tolerance of metal uptake

Module Outline

- M2D1: Environmental heavy metal contamination  Intro
- M2D2: Model system – target selection and engineering approach  Design
- M2D3: Model system – choosing and modifying a chassis 
- M2D4: Screening a system—high throughput vs functional screens  Test
- M2D5: Analysis of elemental metals – laboratory and field approaches 
- M2D6: Applying remediation strategies—advantages and pitfalls  Apply
- M2D7: Engineering a problem-specific bioremediation solution 
- M2D8: Comm Lab  Review

Overview of today's lecture

- **Heavy metals**
 - What are they?
 - What are their uses?
- **How do heavy metals get into environment?**
 - Geogenic sources
 - Anthropogenic sources
- **What happens after heavy metal exposure**
 - To soil
 - To plants
 - To humans
- **How can we mitigate heavy metal contamination?**

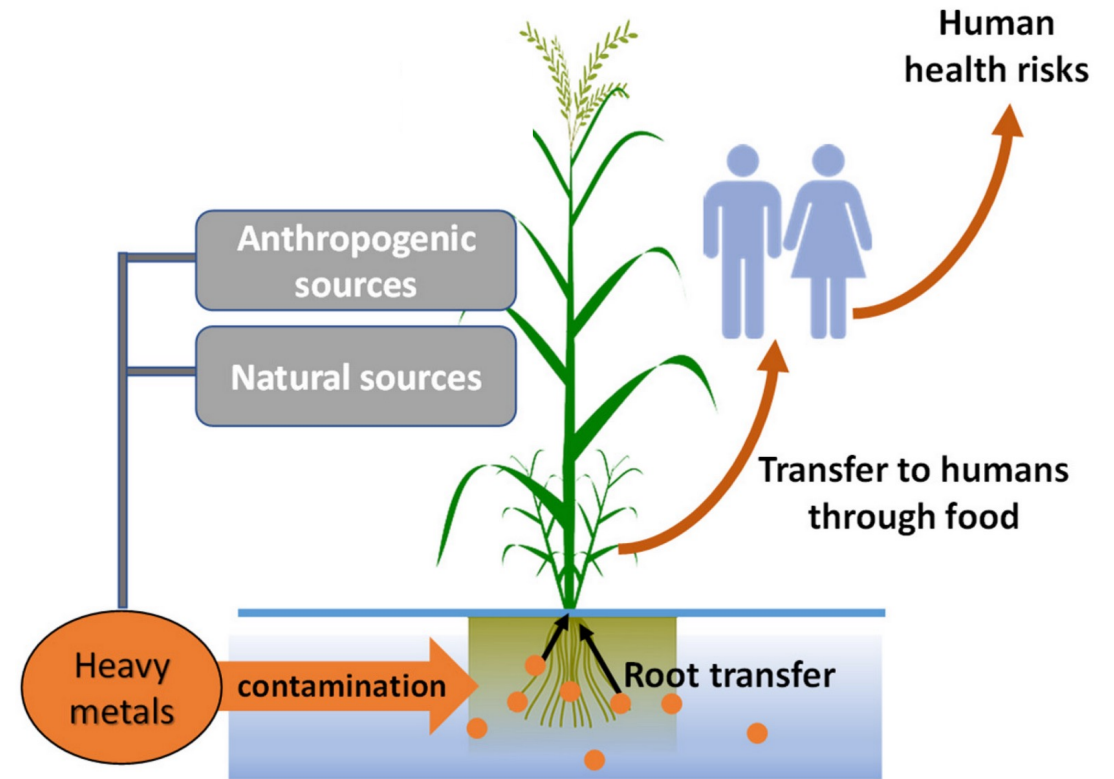

adapted from Uddin et al.

Heavy metals and their uses

Heavy metals



Nickel



Manganese

C
a
d
m
i
u
m



Mercury



Chromium

Copper

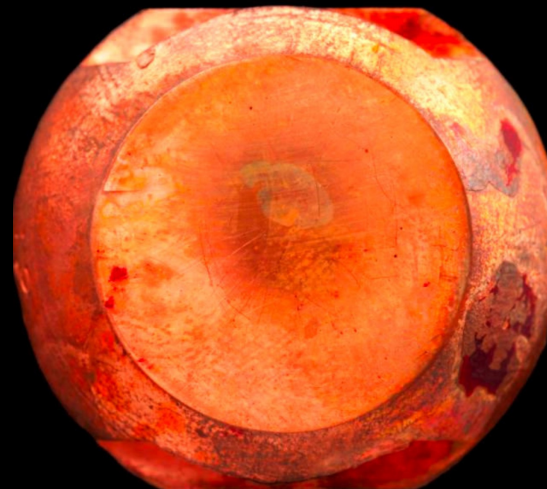

Gold



Cobalt

Heavy metals

Heavy metals is poorly defined as a term

- Relatively high atomic density (greater than 5 g/cm^3)
- Atomic number > 20
- Exhibit metal-like properties

Gold

Nickel

Mercury

Cobalt

Commonly encountered heavy metals have multiple uses

1 H 1.008	2A 2											3A 13	4A 14	5A 15	6A 16	7A 17	8A 18 2 He 4.00
3 Li 6.94	4 Be 9.01											5 B 10.81	6 C 12.01	7 N 14.01	8 O 16.00	9 F 19.00	10 Ne 20.18
11 Na 22.99	12 Mg 24.31	3B 3	4B 4	5B 5	6B 6	7B 7	8B 8 9 10			1B 11	2B 12	13 Al 26.98	14 Si 28.09	15 P 30.97	16 S 32.07	17 Cl 35.45	18 Ar 39.95
19 K 39.10	20 Ca 40.08	21 Sc 44.96	22 Ti 47.87	23 V 50.94	24 Cr 52.00	25 Mn 54.94	26 Fe 55.85	27 Co 58.93	28 Ni 58.69	29 Cu 63.55	30 Zn 65.38	31 Ga 69.72	32 Ge 72.64	33 As 74.92	34 Se 78.96	35 Br 79.90	36 Kr 83.80
37 Rb 85.47	38 Sr 87.62	39 Y 88.91	40 Zr 91.22	41 Nb 92.91	42 Mo 95.96	43 Tc (98)	44 Ru 101.1	45 Rh 102.9	46 Pd 106.4	47 Ag 107.9	48 Cd 112.4	49 In 114.8	50 Sn 118.7	51 Sb 121.8	52 Te 127.6	53 I 126.9	54 Xe 131.3
55 Cs 132.9	56 Ba 137.3	57 La 138.9	72 Hf 178.5	73 Ta 180.9	74 W 183.8	75 Re 186.2	76 Os 190.2	77 Ir 192.2	78 Pt 195.1	79 Au 197.0	80 Hg 200.6	81 Tl 204.4	82 Pb 207.2	83 Bi 209.0	84 Po (209)	85 At (210)	86 Rn (222)
87 Fr (223)	88 Ra (226)	89 Ac (227)	104 Rf (261)	105 Db (262)	106 Sg (266)	107 Bh (264)	108 Hs (277)	109 Mt (268)	110 Ds (281)	111 Rg (281)	112 Cn (285)	113 Nh (286)	114 Fl (289)	115 Mc (289)	116 Lv (293)	117 Ts (293)	118 Og (294)

58 Ce 140.1	59 Pr 140.9	60 Nd 144.2	61 Pm (145)	62 Sm 150.4	63 Eu 152.0	64 Gd 157.3	65 Tb 158.9	66 Dy 162.5	67 Ho 164.9	68 Er 167.3	69 Tm 168.9	70 Yb 173.0	71 Lu 175.0
90 Th 232.0	91 Pa 231.0	92 U 238.0	93 Np (237)	94 Pu (244)	95 Am (243)	96 Cm (247)	97 Bk (247)	98 Cf (251)	99 Es (252)	100 Fm (257)	101 Md (258)	102 No (259)	103 Lr (262)

Metals can act as protein co-factors in human biology

1 H 1.008	2A 2											3A 13	4A 14	5A 15	6A 16	7A 17	2 He 4.00
3 Li 6.94	4 Be 9.01											5 B 10.81	6 C 12.01	7 N 14.01	8 O 16.00	9 F 19.00	10 Ne 20.18
11 Na 22.99	12 Mg 24.31	3B 3	4B 4	5B 5	6B 6	7B 7	8B 8 9 10			1B 11	2B 12	13 Al 26.98	14 Si 28.09	15 P 30.97	16 S 32.07	17 Cl 35.45	18 Ar 39.95
19 K 39.10	20 Ca 40.08	21 Sc 44.96	22 Ti 47.87	23 V 50.94	24 Cr 52.00	25 Mn 54.94	26 Fe 55.85	27 Co 58.93	28 Ni 58.69	29 Cu 63.55	30 Zn 65.38	31 Ga 69.72	32 Ge 72.64	33 As 74.92	34 Se 78.96	35 Br 79.90	36 Kr 83.80
37 Rb 85.47	38 Sr 87.62	39 Y 88.91	40 Zr 91.22	41 Nb 92.91	42 Mo 95.96	43 Tc (98)	44 Ru 101.1	45 Rh 102.9	46 Pd 106.4	47 Ag 107.9	48 Cd 112.4	49 In 114.8	50 Sn 118.7	51 Sb 121.8	52 Te 127.6	53 I 126.9	54 Xe 131.3
55 Cs 132.9	56 Ba 137.3	57 La 138.9	72 Hf 178.5	73 Ta 180.9	74 W 183.8	75 Re 186.2	76 Os 190.2	77 Ir 192.2	78 Pt 195.1	79 Au 197.0	80 Hg 200.6	81 Tl 204.4	82 Pb 207.2	83 Bi 209.0	84 Po (209)	85 At (210)	86 Rn (222)
87 Fr (223)	88 Ra (226)	89 Ac (227)	104 Rf (261)	105 Db (262)	106 Sg (266)	107 Bh (264)	108 Hs (277)	109 Mt (268)	110 Ds (281)	111 Rg (281)	112 Cn (285)	113 Nh (286)	114 Fl (289)	115 Mc (289)	116 Lv (293)	117 Ts (293)	118 Og (294)

58 Ce 140.1	59 Pr 140.9	60 Nd 144.2	61 Pm (145)	62 Sm 150.4	63 Eu 152.0	64 Gd 157.3	65 Tb 158.9	66 Dy 162.5	67 Ho 164.9	68 Er 167.3	69 Tm 168.9	70 Yb 173.0	71 Lu 175.0
90 Th 232.0	91 Pa 231.0	92 U 238.0	93 Np (237)	94 Pu (244)	95 Am (243)	96 Cm (247)	97 Bk (247)	98 Cf (251)	99 Es (252)	100 Fm (257)	101 Md (258)	102 No (259)	103 Lr (262)

Metals crucial for metabolic activity are also known as essential elements

Cobalt

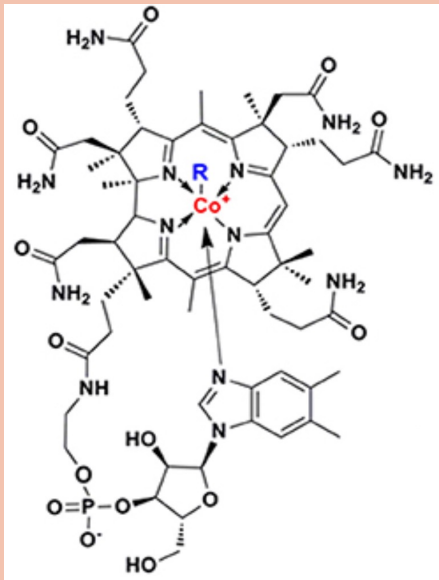

vitamin B12

Iron

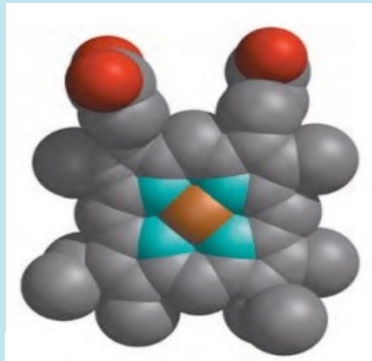

Heme β subunit

Zinc

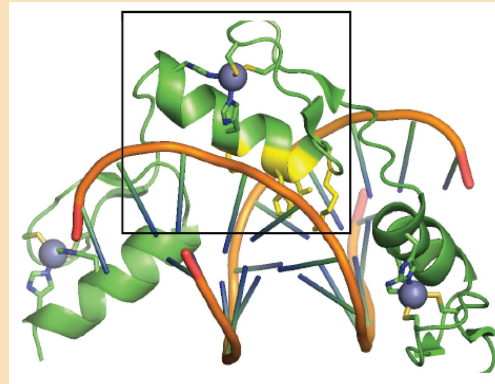

zinc finger motif

Manganese / Copper

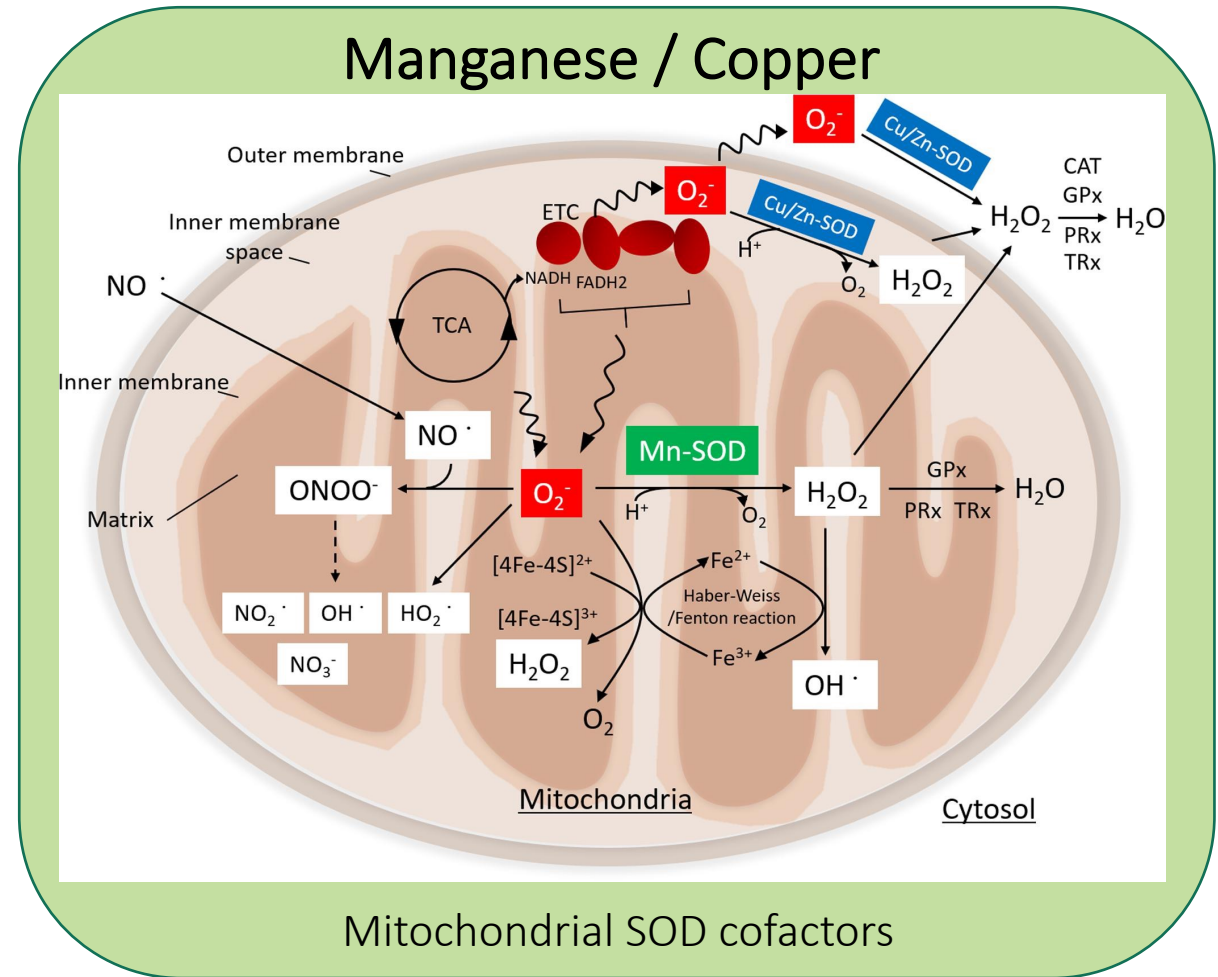

Mitochondrial SOD cofactors

Heavy metals have value as “precious metals”

1A 1		2A 2										3A 13	4A 14	5A 15	6A 16	7A 17	8A 18
1 H 1.008																	2 He 4.00
3 Li 6.94	4 Be 9.01											5 B 10.81	6 C 12.01	7 N 14.01	8 O 16.00	9 F 19.00	10 Ne 20.18
11 Na 22.99	12 Mg 24.31	3B 3	4B 4	5B 5	6B 6	7B 7	8B 8 9 10			1B 11	2B 12	13 Al 26.98	14 Si 28.09	15 P 30.97	16 S 32.07	17 Cl 35.45	18 Ar 39.95
19 K 39.10	20 Ca 40.08	21 Sc 44.96	22 Ti 47.87	23 V 50.94	24 Cr 52.00	25 Mn 54.94	26 Fe 55.85	27 Co 58.93	28 Ni 58.69	29 Cu 63.55	30 Zn 65.38	31 Ga 69.72	32 Ge 72.64	33 As 74.92	34 Se 78.96	35 Br 79.90	36 Kr 83.80
37 Rb 85.47	38 Sr 87.62	39 Y 88.91	40 Zr 91.22	41 Nb 92.91	42 Mo 95.96	43 Tc (98)	44 Ru 101.1	45 Rh 102.9	46 Pd 106.4	47 Ag 107.9	48 Cd 112.4	49 In 114.8	50 Sn 118.7	51 Sb 121.8	52 Te 127.6	53 I 126.9	54 Xe 131.3
55 Cs 132.9	56 Ba 137.3	57 La 138.9	72 Hf 178.5	73 Ta 180.9	74 W 183.8	75 Re 186.2	76 Os 190.2	77 Ir 192.2	78 Pt 195.1	79 Au 197.0	80 Hg 200.6	81 Tl 204.4	82 Pb 207.2	83 Bi 209.0	84 Po (209)	85 At (210)	86 Rn (222)
87 Fr (223)	88 Ra (226)	89 Ac (227)	104 Rf (261)	105 Db (262)	106 Sg (266)	107 Bh (264)	108 Hs (277)	109 Mt (268)	110 Ds (281)	111 Rg (281)	112 Cn (285)	113 Nh (286)	114 Fl (289)	115 Mc (289)	116 Lv (293)	117 Ts (293)	118 Og (294)

58 Ce 140.1	59 Pr 140.9	60 Nd 144.2	61 Pm (145)	62 Sm 150.4	63 Eu 152.0	64 Gd 157.3	65 Tb 158.9	66 Dy 162.5	67 Ho 164.9	68 Er 167.3	69 Tm 168.9	70 Yb 173.0	71 Lu 175.0
90 Th 232.0	91 Pa 231.0	92 U 238.0	93 Np (237)	94 Pu (244)	95 Am (243)	96 Cm (247)	97 Bk (247)	98 Cf (251)	99 Es (252)	100 Fm (257)	101 Md (258)	102 No (259)	103 Lr (262)

Precious metals have economic and cultural value



Gold: \$1,858 / oz

Au

Silver: \$21 / oz

Ag



Platinum: \$979 / oz

Pt



Many heavy metals play a role in manufacturing

1A 1																	8A 18
1 H 1.008	2A 2											3A 13	4A 14	5A 15	6A 16	7A 17	2 He 4.00
3 Li 6.94	4 Be 9.01											5 B 10.81	6 C 12.01	7 N 14.01	8 O 16.00	9 F 19.00	10 Ne 20.18
11 Na 22.99	12 Mg 24.31	3B 3	4B 4	5B 5	6B 6	7B 7	8B 8 9 10			1B 11	2B 12	13 Al 26.98	14 Si 28.09	15 P 30.97	16 S 32.07	17 Cl 35.45	18 Ar 39.95
19 K 39.10	20 Ca 40.08	21 Sc 44.96	22 Ti 47.87	23 V 50.94	24 Cr 52.00	25 Mn 54.94	26 Fe 55.85	27 Co 58.93	28 Ni 58.69	29 Cu 63.55	30 Zn 65.38	31 Ga 69.72	32 Ge 72.64	33 As 74.92	34 Se 78.96	35 Br 79.90	36 Kr 83.80
37 Rb 85.47	38 Sr 87.62	39 Y 88.91	40 Zr 91.22	41 Nb 92.91	42 Mo 95.96	43 Tc (98)	44 Ru 101.1	45 Rh 102.9	46 Pd 106.4	47 Ag 107.9	48 Cd 112.4	49 In 114.8	50 Sn 118.7	51 Sb 121.8	52 Te 127.6	53 I 126.9	54 Xe 131.3
55 Cs 132.9	56 Ba 137.3	57 La 138.9	72 Hf 178.5	73 Ta 180.9	74 W 183.8	75 Re 186.2	76 Os 190.2	77 Ir 192.2	78 Pt 195.1	79 Au 197.0	80 Hg 200.6	81 Tl 204.4	82 Pb 207.2	83 Bi 209.0	84 Po (209)	85 At (210)	86 Rn (222)
87 Fr (223)	88 Ra (226)	89 Ac (227)	104 Rf (261)	105 Db (262)	106 Sg (266)	107 Bh (264)	108 Hs (277)	109 Mt (268)	110 Ds (281)	111 Rg (281)	112 Cn (285)	113 Nh (286)	114 Fl (289)	115 Mc (289)	116 Lv (293)	117 Ts (293)	118 Og (294)

58 Ce 140.1	59 Pr 140.9	60 Nd 144.2	61 Pm (145)	62 Sm 150.4	63 Eu 152.0	64 Gd 157.3	65 Tb 158.9	66 Dy 162.5	67 Ho 164.9	68 Er 167.3	69 Tm 168.9	70 Yb 173.0	71 Lu 175.0
90 Th 232.0	91 Pa 231.0	92 U 238.0	93 Np (237)	94 Pu (244)	95 Am (243)	96 Cm (247)	97 Bk (247)	98 Cf (251)	99 Es (252)	100 Fm (257)	101 Md (258)	102 No (259)	103 Lr (262)

Heavy metals are used to manufacture common materials

Dyes and Pigments

Prussian Blue

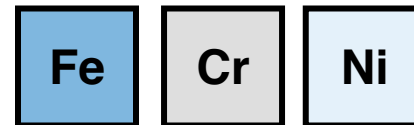
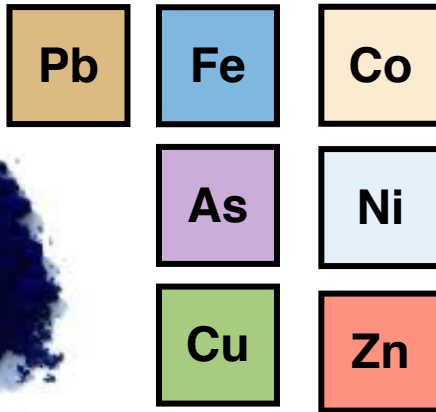

Stainless Steel



Heavy metals are frequently used in coating and electroplating for everything from automotive to aerospace machinery

Chrome plating



Zn

Ni

Cu

Au

Pt

Cd

Mn

Ag

Cr



Batteries utilize heavy metals

Lead-Acid battery

- Pt
- Au
- Pb



Alkaline batteries

- Cd
- Ni
- Mn
- Zn



EV Battery

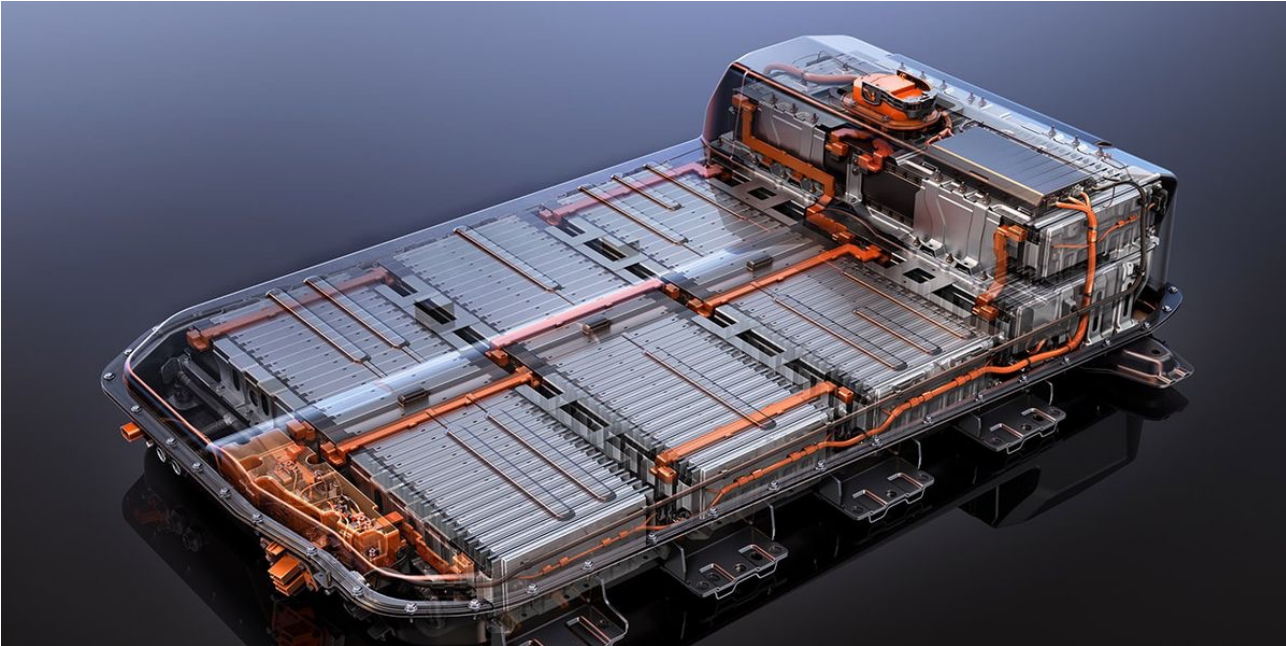

- Cu
- Ni
- Mn
- Co

Photovoltaic cells, photoresistors, infrared detectors all use heavy metals

Infrared detectors & Photoresistors

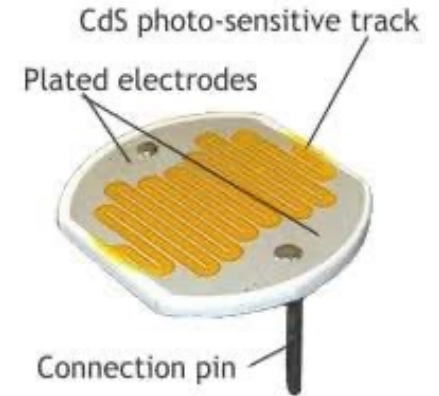
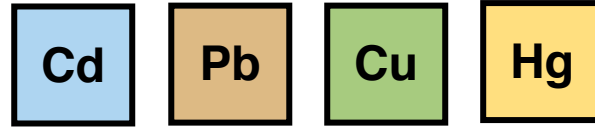

Solar photovoltaic cells

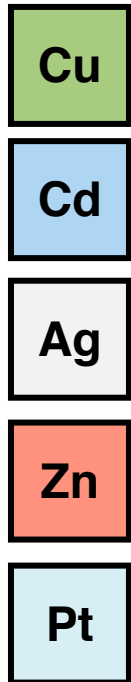

Cadmium-Telluride

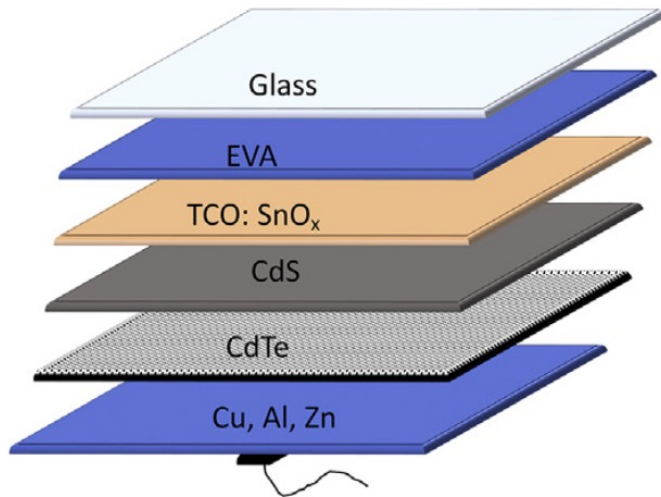

crystalline-Silicon

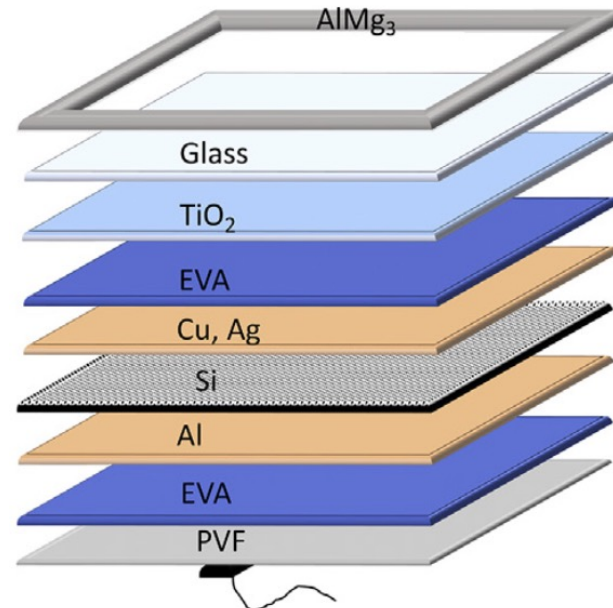

Some heavy metals are highly toxic at low exposure levels

1A 1 1 H 1.008																	2 2 He 4.00
3 Li 6.94	4 Be 9.01											5 B 10.81	6 C 12.01	7 N 14.01	8 O 16.00	9 F 19.00	10 Ne 20.18
11 Na 22.99	12 Mg 24.31	3B 3	4B 4	5B 5	6B 6	7B 7	8B 8 9 10			1B 11	2B 12	13 Al 26.98	14 Si 28.09	15 P 30.97	16 S 32.07	17 Cl 35.45	18 Ar 39.95
19 K 39.10	20 Ca 40.08	21 Sc 44.96	22 Ti 47.87	23 V 50.94	24 Cr 52.00	25 Mn 54.94	26 Fe 55.85	27 Co 58.93	28 Ni 58.69	29 Cu 63.55	30 Zn 65.38	31 Ga 69.72	32 Ge 72.64	33 As 74.92	34 Se 78.96	35 Br 79.90	36 Kr 83.80
37 Rb 85.47	38 Sr 87.62	39 Y 88.91	40 Zr 91.22	41 Nb 92.91	42 Mo 95.96	43 Tc (98)	44 Ru 101.1	45 Rh 102.9	46 Pd 106.4	47 Ag 107.9	48 Cd 112.4	49 In 114.8	50 Sn 118.7	51 Sb 121.8	52 Te 127.6	53 I 126.9	54 Xe 131.3
55 Cs 132.9	56 Ba 137.3	57 La 138.9	72 Hf 178.5	73 Ta 180.9	74 W 183.8	75 Re 186.2	76 Os 190.2	77 Ir 192.2	78 Pt 195.1	79 Au 197.0	80 Hg 200.6	81 Tl 204.4	82 Pb 207.2	83 Bi 209.0	84 Po (209)	85 At (210)	86 Rn (222)
87 Fr (223)	88 Ra (226)	89 Ac (227)	104 Rf (261)	105 Db (262)	106 Sg (266)	107 Bh (264)	108 Hs (277)	109 Mt (268)	110 Ds (281)	111 Rg (281)	112 Cn (285)	113 Nh (286)	114 Fl (289)	115 Mc (289)	116 Lv (293)	117 Ts (293)	118 Og (294)

58 Ce 140.1	59 Pr 140.9	60 Nd 144.2	61 Pm (145)	62 Sm 150.4	63 Eu 152.0	64 Gd 157.3	65 Tb 158.9	66 Dy 162.5	67 Ho 164.9	68 Er 167.3	69 Tm 168.9	70 Yb 173.0	71 Lu 175.0
90 Th 232.0	91 Pa 231.0	92 U 238.0	93 Np (237)	94 Pu (244)	95 Am (243)	96 Cm (247)	97 Bk (247)	98 Cf (251)	99 Es (252)	100 Fm (257)	101 Md (258)	102 No (259)	103 Lr (262)

Environmental contamination and its consequences

There are 2 main routes of heavy metal release into the environment

Geogenic sources



Weathering of rocks

Volcanoes

Anthropogenic sources

Agrochemicals

Industrial activity

Smelting and mining activity

Sewage and waste disposal

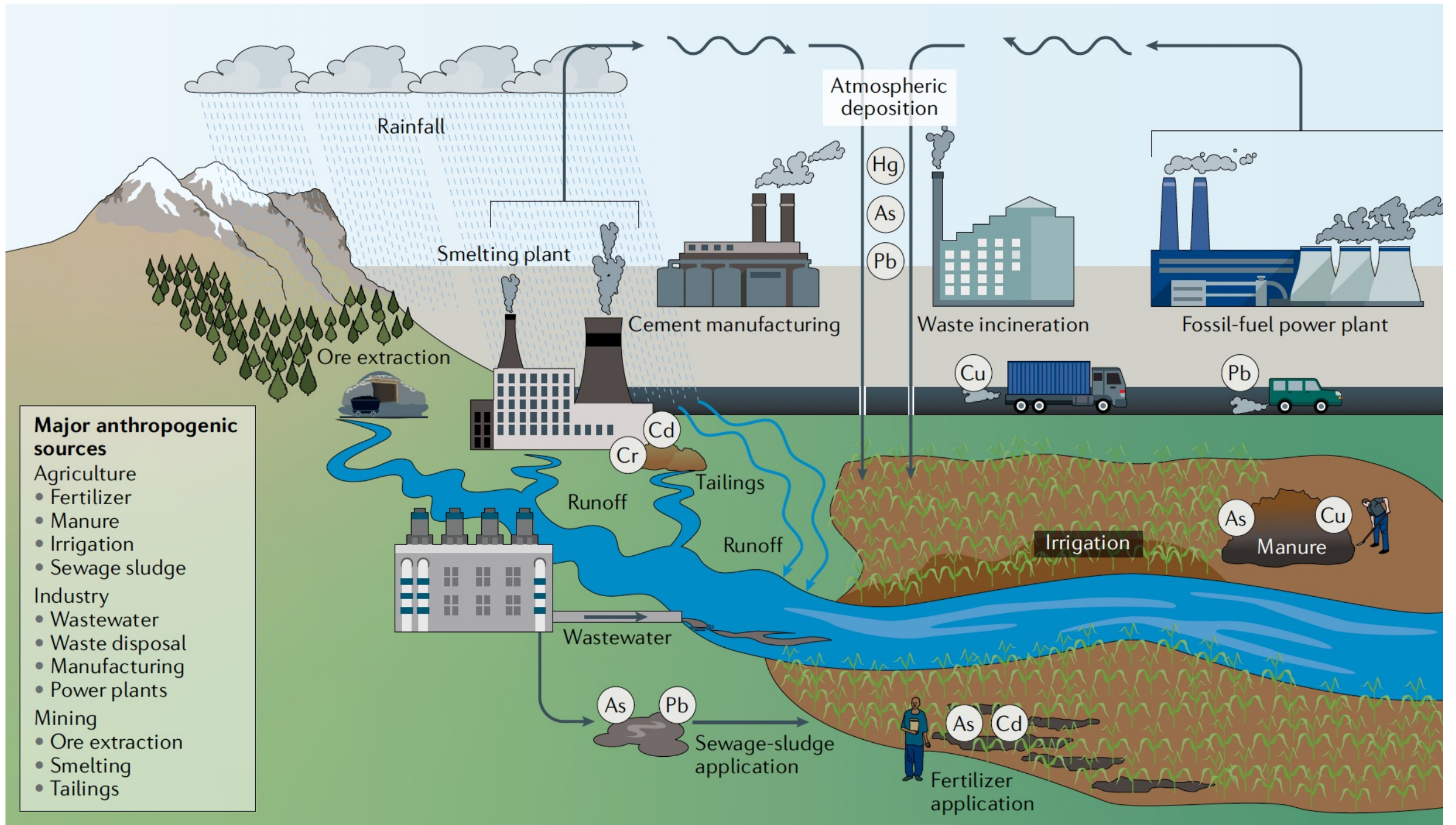

Agrochemicals release heavy metals into the soil

Fertilizers

- Sewage sludge fertilizer contains heavy metals
- Fly ash from coal plants
- Inorganic phosphate-based fertilizers increase cadmium in the soil
 - Some disagreement if the fertilizers release cadmium or increase bioavailability

Pesticides and fungicides

- Can contain heavy metals as contaminants



Industrial activity contributes to heavy metal contamination

- Coal-fired power stations release:
 - Cu, Zn, Cd, Ni
- Chemical processing which involves heavy metals is required to produce common goods
 - Plastics
 - textiles
 - electronics
 - wood preservatives
 - automotive components
- The waste generated in manufacturing can leach into the environment



Smelting and mining activity produce metal contaminants



Mining

- Disruption of sedimentary layers can release embedded heavy metals
- Waste runoff from mining sites contaminates water

Smelting

- Slag generated from refinement of metal can contain contaminants
 - Smelting zinc produces slag containing lead and cadmium
- Heavy metal particulates are also released

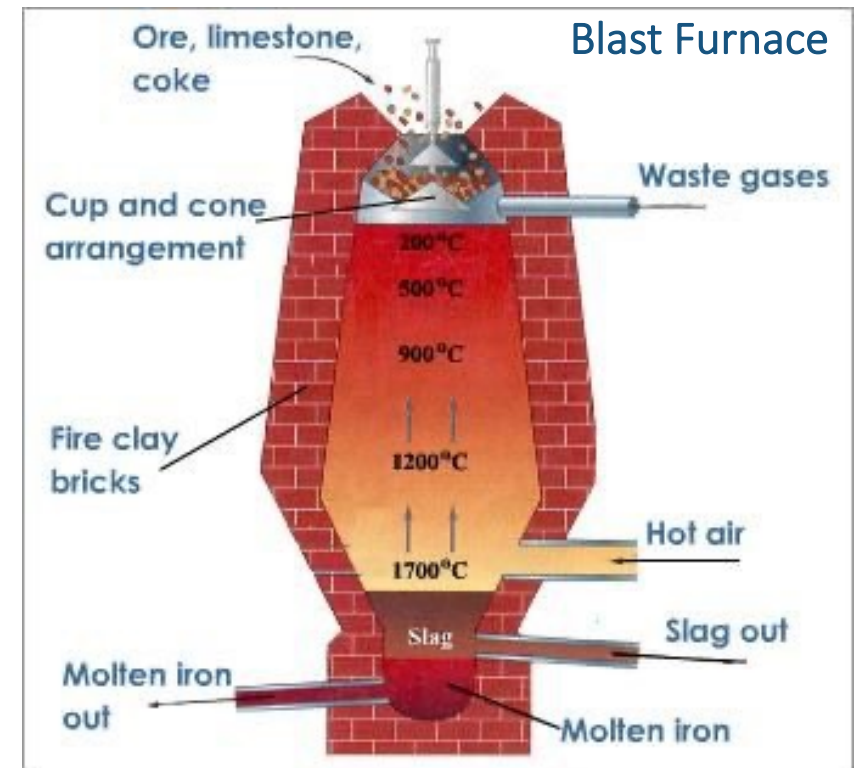

Heavy metals fundamentally change soil microbial richness

- Decrease in **soil viability**
 - lower microbial biomass
 - less biodiversity
- Reduced **nitrogen fixing**
- Reduced microbial **metabolism**
 - reduced essential enzyme activities
 - reduced litter breakdown
- Altered microbial communication
- Changes in soil ecosystem

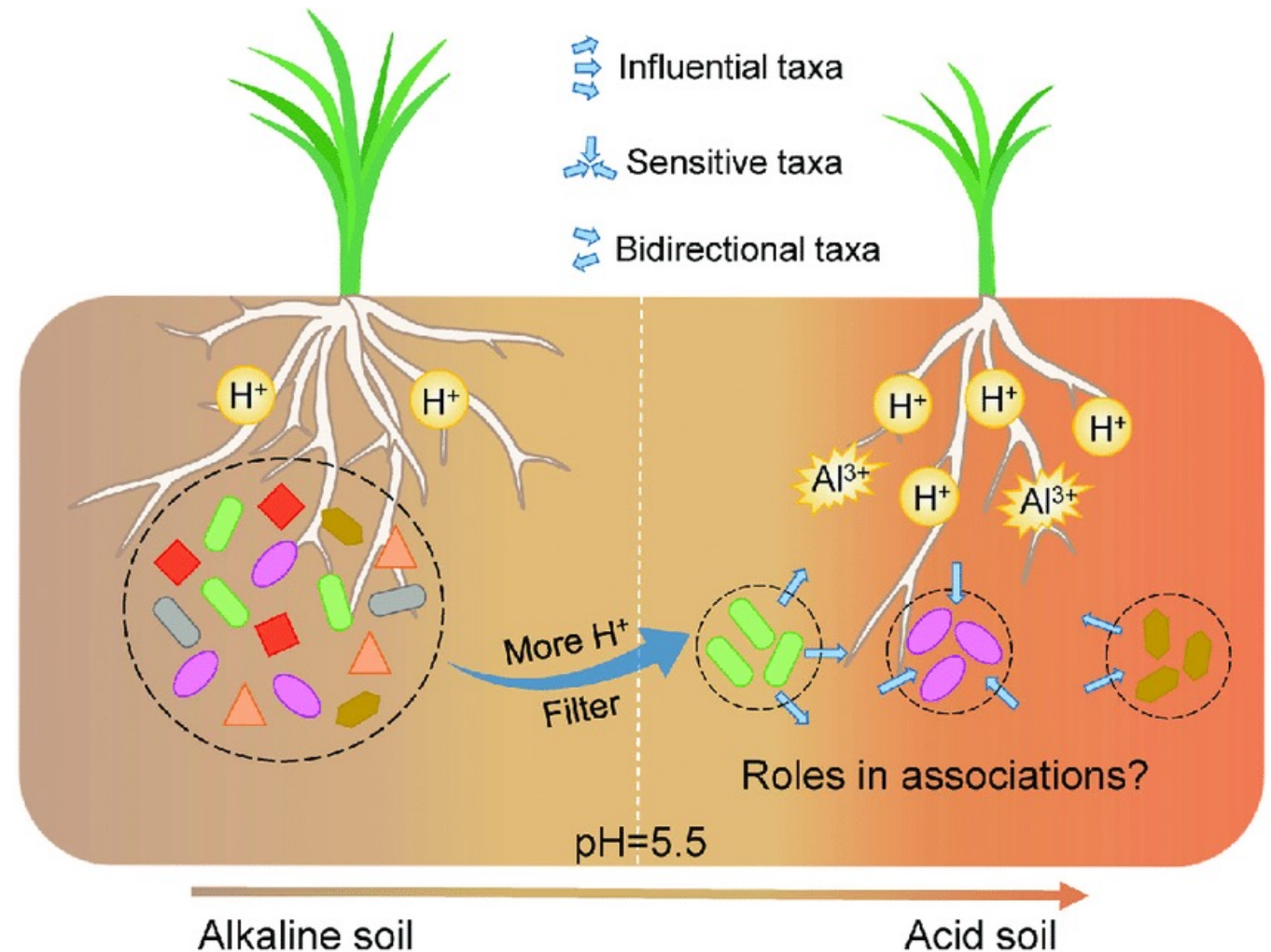

Heavy metal accumulates in plants and disrupts essential biology

- Most heavy metal enters the plant through the **roots** and accumulates there

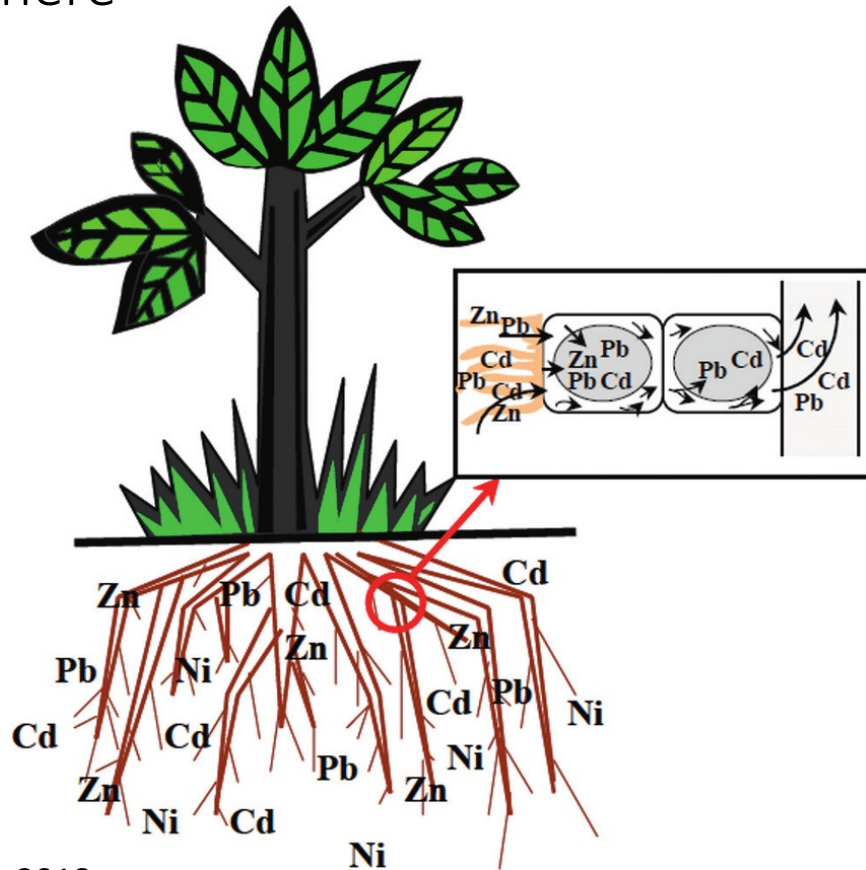

- General stress response
 - obstruct chloroplast structure
 - disrupt electron transport

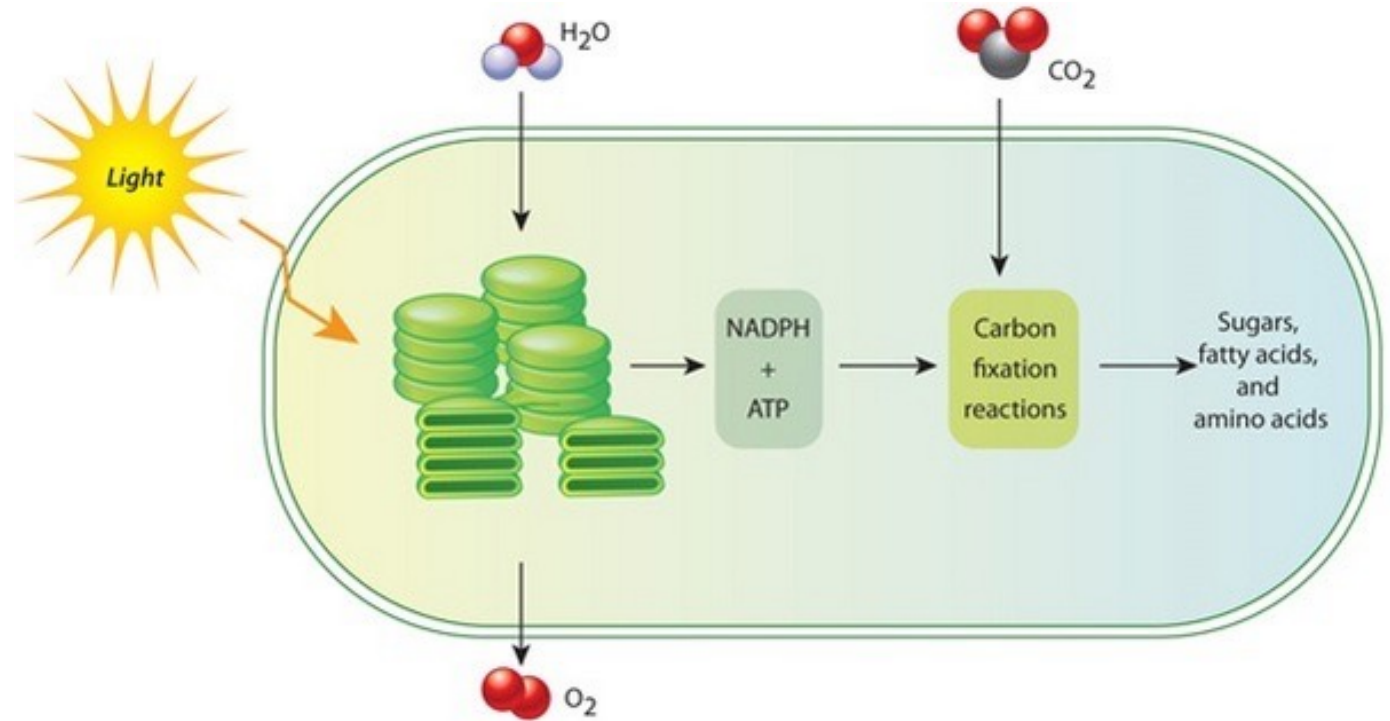

Heavy metal exposure has wide ranging effects on human health

Routes of exposure

- Inhalation
- Ingestion
- Dermal

Health effects

- Systemic toxicity
- Damage of multiple organs

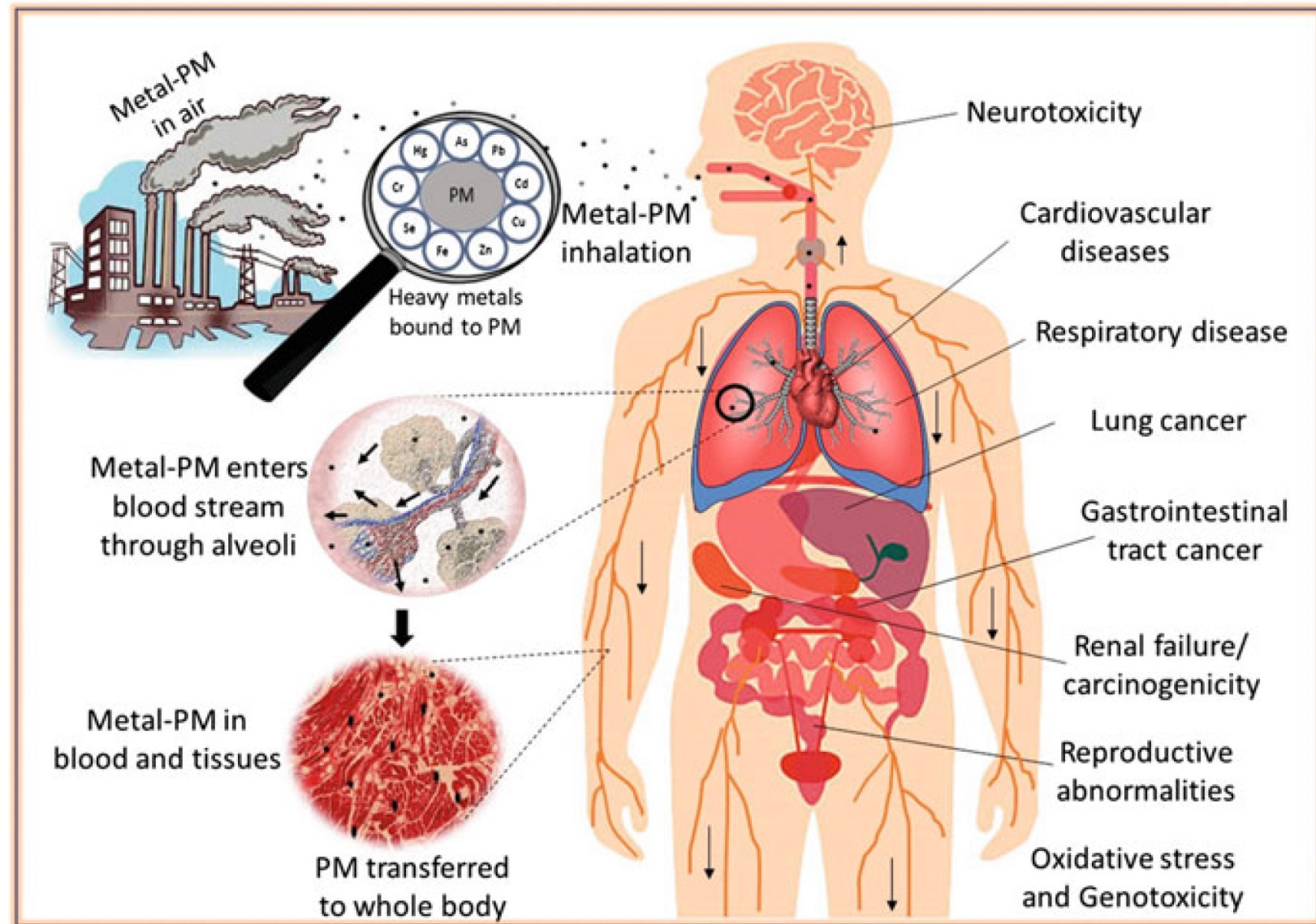

There are multiple proposed mechanisms for metal toxicity

Protein disruption

- Inhibit enzymes through thiol, sulfhydryl, amide group binding
 - Broad enzyme inhibition
- Inhibits enzymes involved in DNA damage repair
 - Many heavy metals are known or putative carcinogens
- Replace essential metal cations and cofactors

Oxidative stress

- Disrupt mitochondrial function
- Generate reactive oxygen species

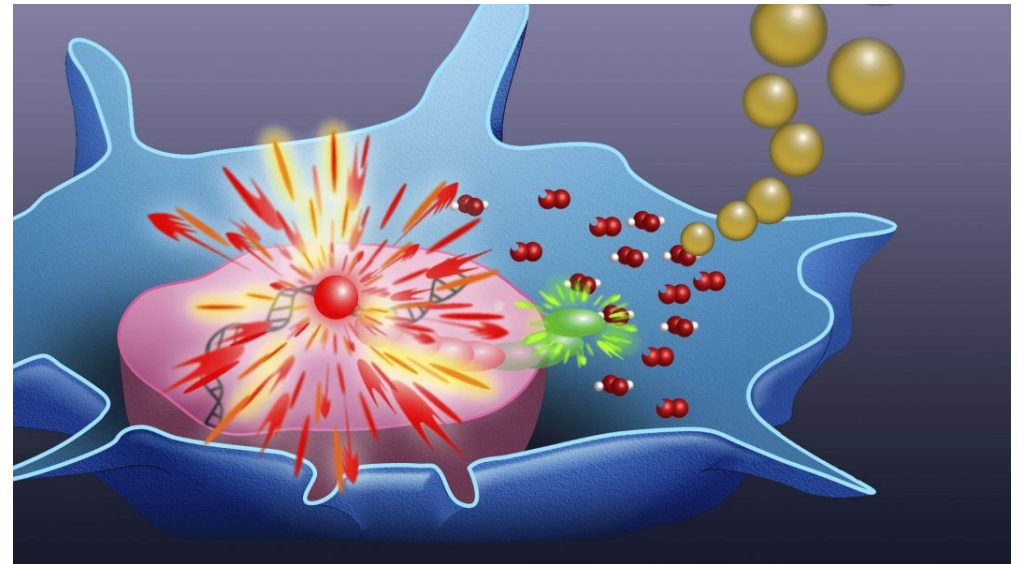

What can we do to mitigate this issue?

Physical and chemical mitigation of heavy metal contamination

Soil Amendment with Biochar

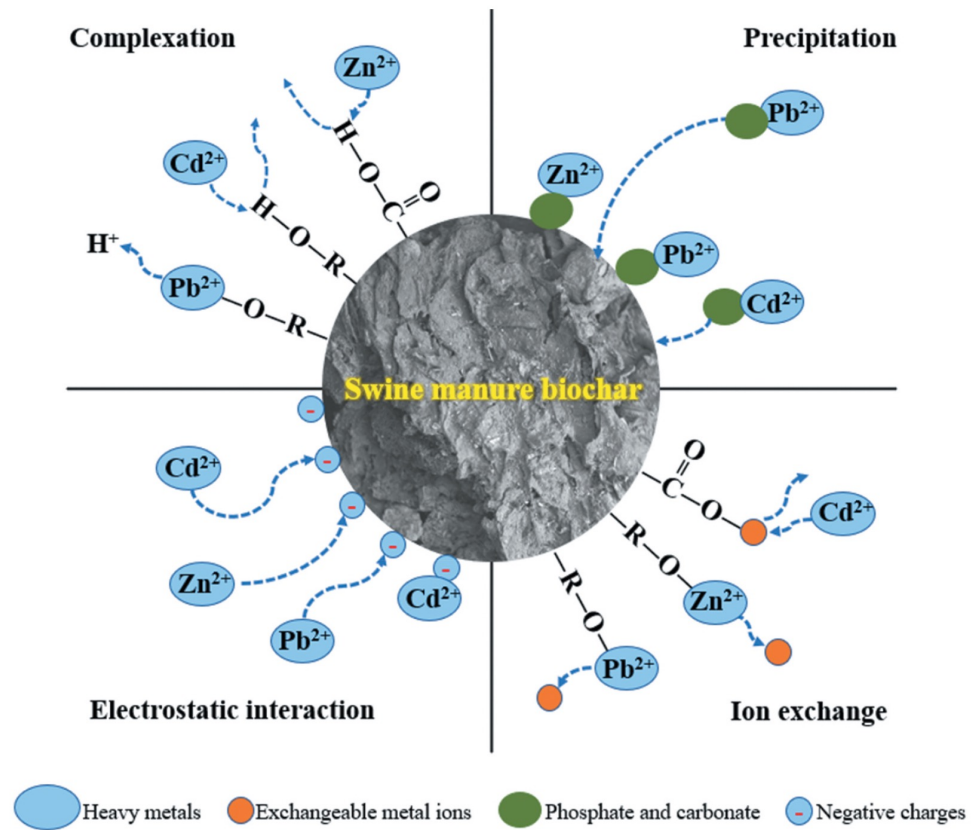

Electrokinetic remediation

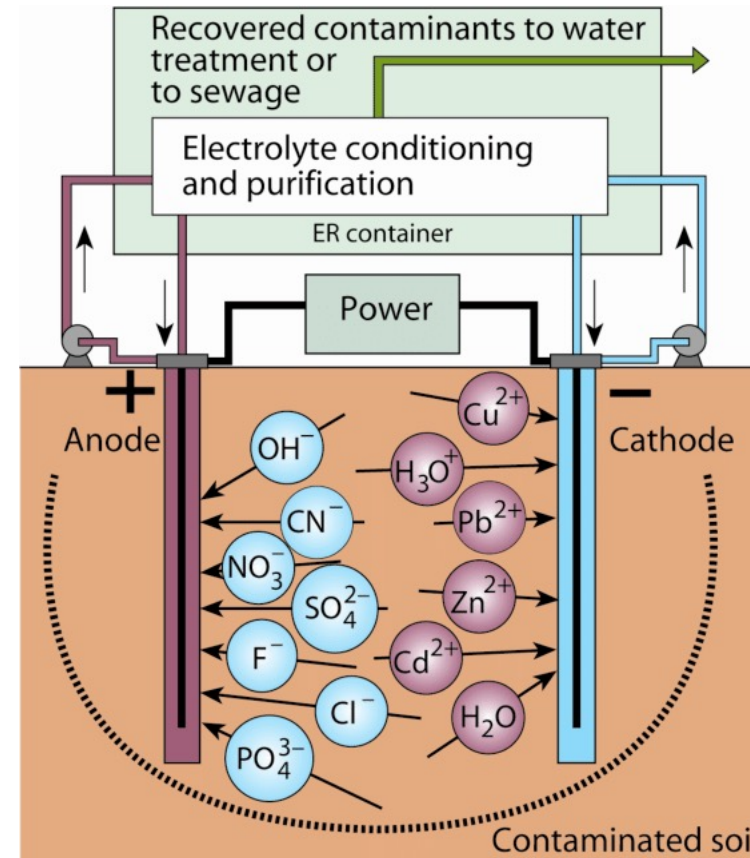

- Soil excavation / soil washing
- Chemical precipitation from wastewater

Bioremediation is a useful tool to mitigate heavy metal contamination

- Bacteria, yeast, and plants have natural defenses against heavy metal damage
- These defenses can be engineered to create effective remediation models for pollutants

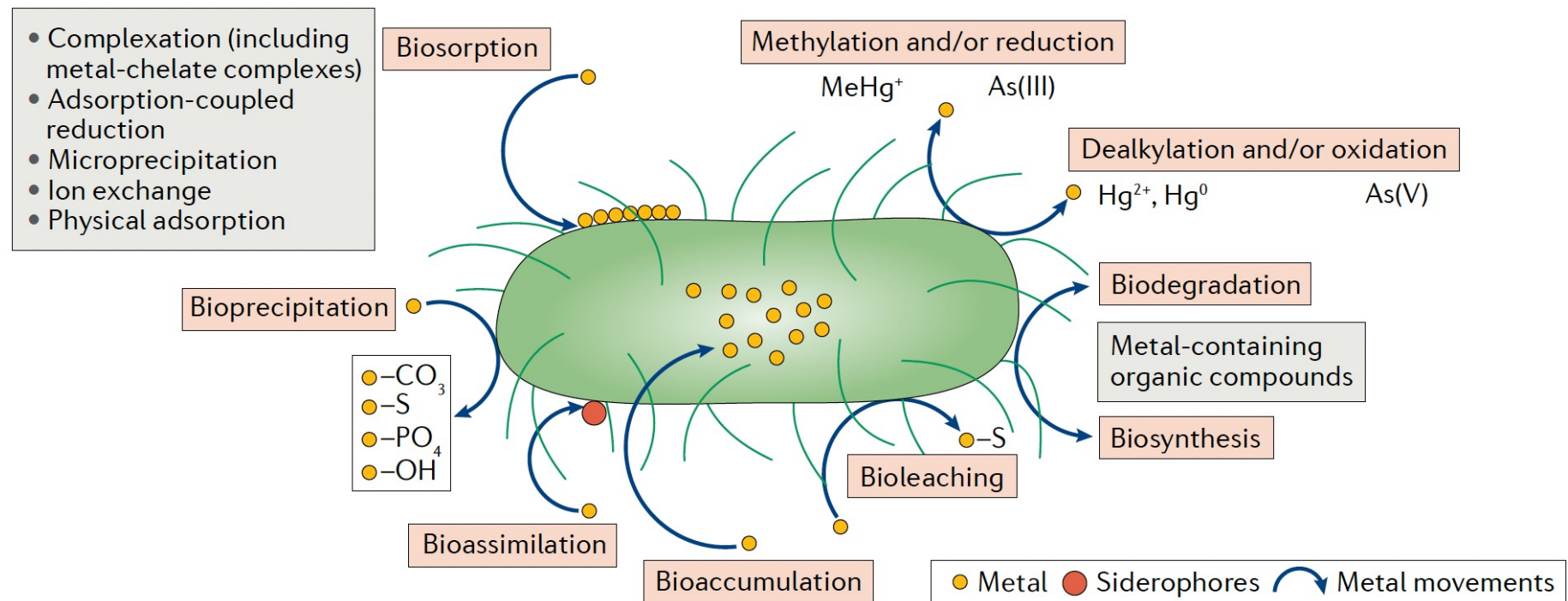

How does this all relate to your Mod2 project?

- Begin the **early stages** of the process to create **bioremediation model**
- Alter a *Saccharomyces cerevisiae* cell surface protein
 - **Fet4**
 - Low-affinity iron permease reported to take up other metals
- Use **rational design protein engineering** to create a mutant form of Fet4
 - Reduce preference of Fet4 for **iron** and identify mutations that increase preference for **cadmium**
- Explore mutagenesis and functional screening

In lab today and tomorrow

- Examine secondary and tertiary structure of Fet4 and previous literature to determine mutations that have the potential to alter affinity of the transporter from iron to cadmium
- Design mutagenesis primers to create your designed mutation

